

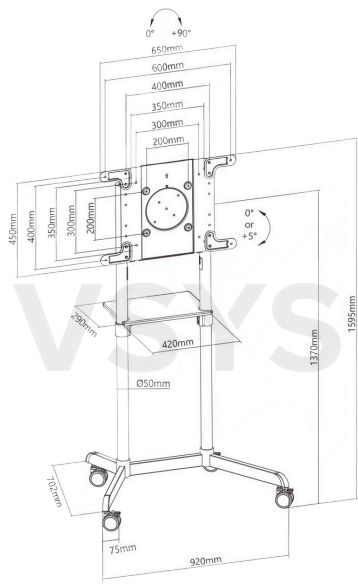







Rotating Interactive Display Stand
For 37"-70" Displays



-  Screen Size
37" - 70"
-  DVD/AV RATED
5 kg/11lb
-  70 kg/154lb
-  Tilt Range
0° or 5°
-  Cable Management
-  VESA Compatible
200x200 400x200
600x200 300x300
350x350 400x300
400x400 600x400
-  Screen Rotation
0°-+90°
-  Direction Indicator

Product Category:	Interactive Whiteboard Cart/Mobile Interactive Whiteboard Stand
Rank:	Standard
Material:	Steel, Plastic, MDF & Melamine
Metal Sheet Thickness:	VESA Panel THK=2mm cold-rolled sheet (VESA Panel THK=0.079" cold-rolled sheet)

Column Size (main Column/Extension Column):	ø50x1.5x1389mm (ø2"x0.059"x54.7")
Fit Screen Size:	37"-70"
VESA Compatible:	200x200, 400x200, 300x300, 600x200, 350x350, 400x400, 600x400
TV Weight Capacity:	70kn (154lbs)

Strength Tested:	4 times approved
Screen Quantity:	1
Tilt Range:	0° or 5°
Screen Rotation:	0°-+90°
TV Height Adjustable:	No
Shelf Weight Capacity:	5kg (11lbs)
Cable Management:	Yes
Base Type:	Caster
Accessory Kit Package:	Normal/Ziplock Polybag, Compartment Polybag
Direction Indicator:	Yes



Cable Management

For Clutter Free & Organized Cables/wires



MDF Equipment Shelf